

Aluminium floor plate for square section trusses
Piastra per traliccio quadro in alluminio

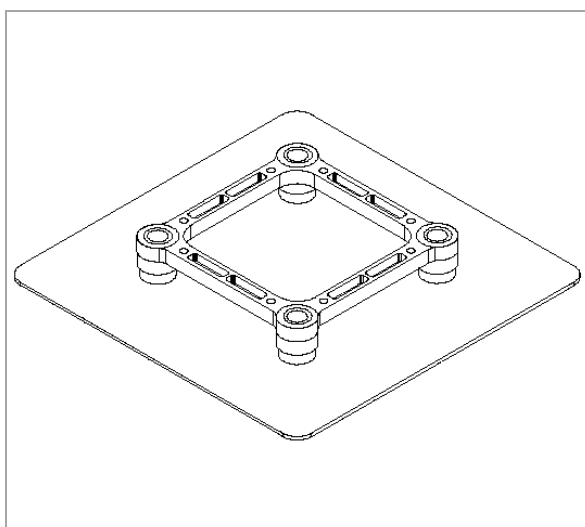
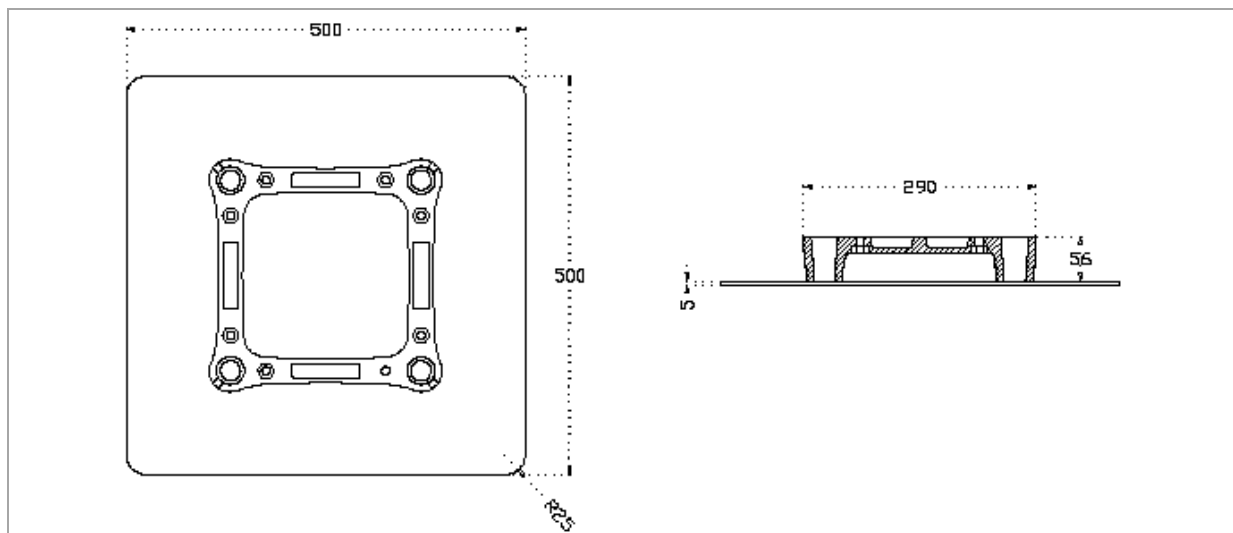

TECHNICAL SPECIFICATION

Dimension	500 x 500 x 61 mm
Material	Aluminium EN AW 6082 T6
Weight	5.80 kg
Compatible	Square section 29 cm
Volume	0.015 mc