

Terminale sezione piana con predisposizione per AM02T

Terminal flat section with provision for AM02T

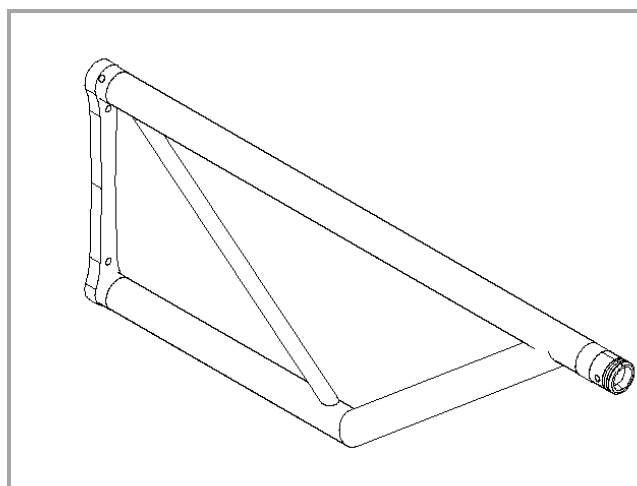
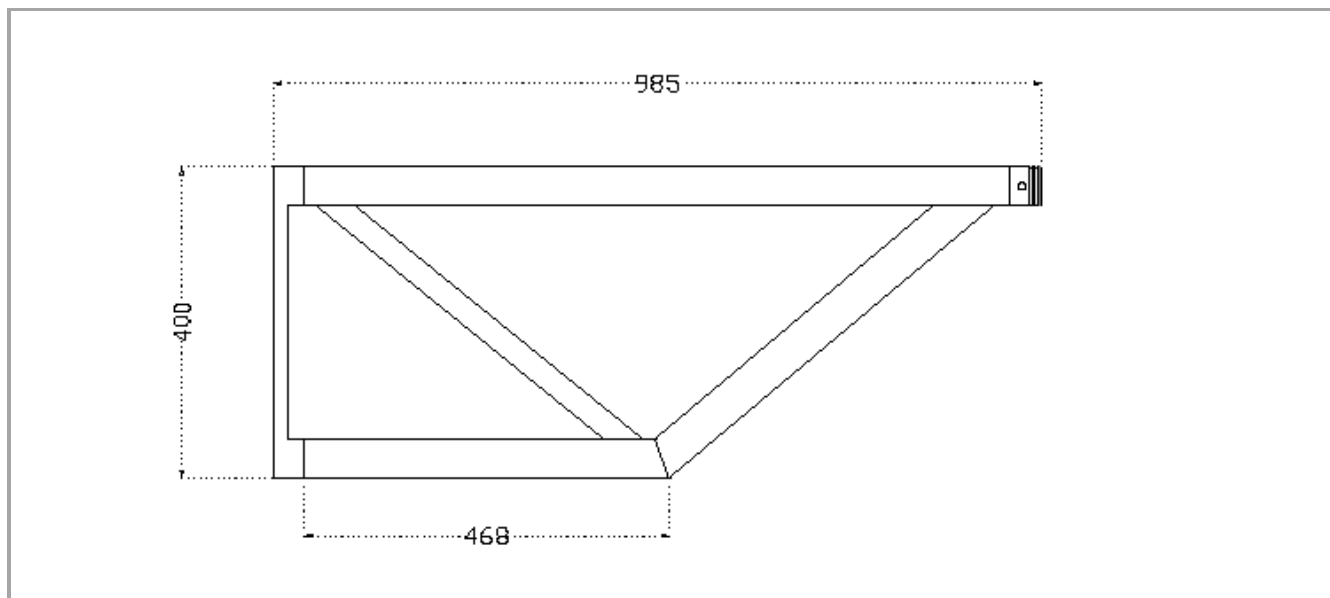

Specifica Tecnica / Technical specification

Dimensioni / Dimensions:	985x400x50 mm
Materiale / Material	Aluminium EN AW 6082 T6
Saldatura / Welding	TIG* UNI EN 287-2
Volume / volume	0.020 mc
Corrente principale / Main tubes	Ø 50x3.0 mm
Trasversale /Diagonals	Ø 30x3 mm
Peso / Weight	5.20 Kg