

Assembly tool for **DELTA** Dado box spigot
Dima di montaggio per DELTA Dado

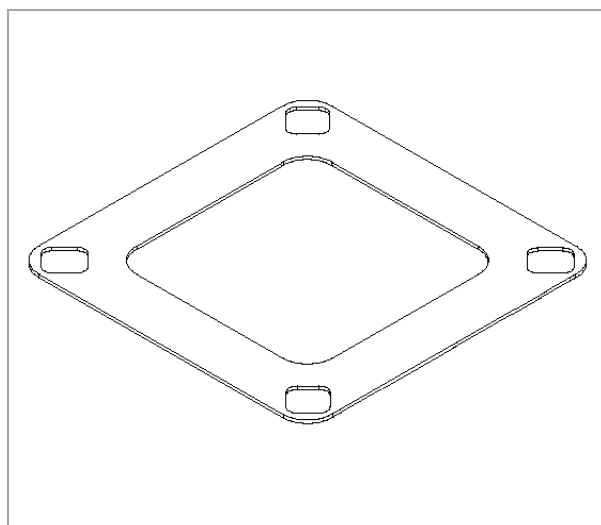
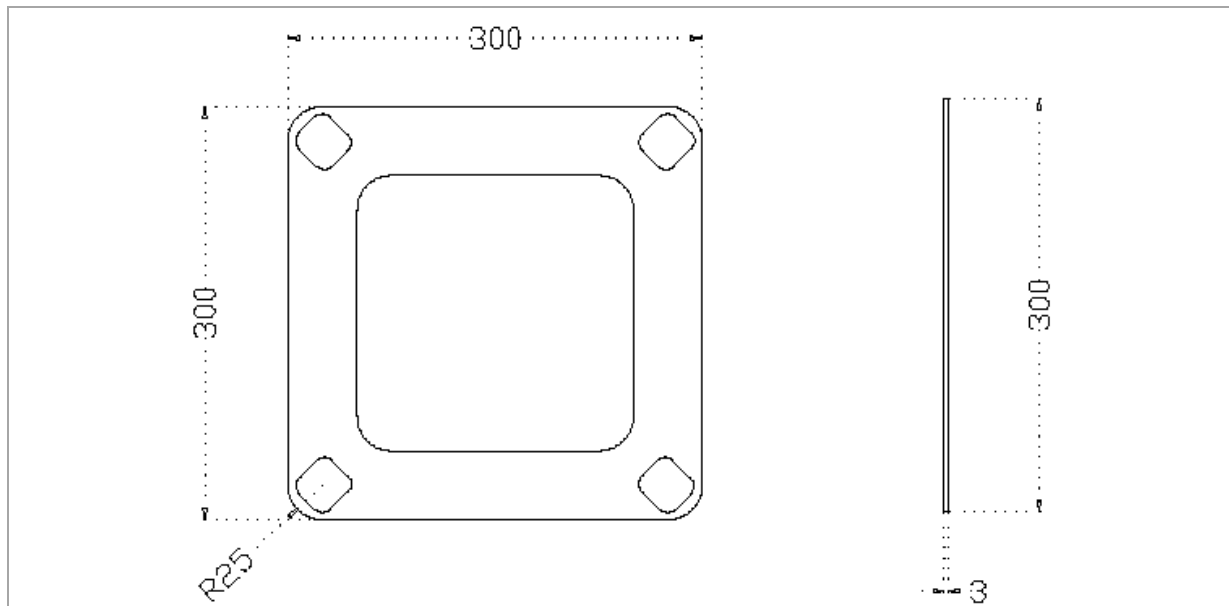

TECHNICAL SPECIFICATION

Dimension	300x300x3 mm
Material	galvanized steel
Weight	1.03 kg
Compatible	Square Truss 29 cm
Volume	0.0027 mc

ACCESSORIES