

GC/01AG*
GC/01ANG**

**GANCIO A "C" IN ALLUMINIO Sp. 31mm CON GOLFARE
COMPATIBILE TUBO DIAMETRO DA 48 A 51 mm
PORTATA 100 KG**

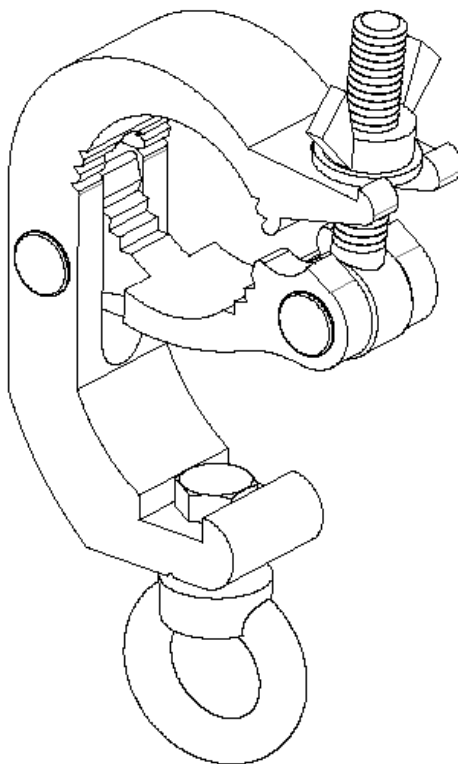

Finitura alluminio lucido() o verniciato nero(**)*



ASSEMBLAGGIO ACCESSORI

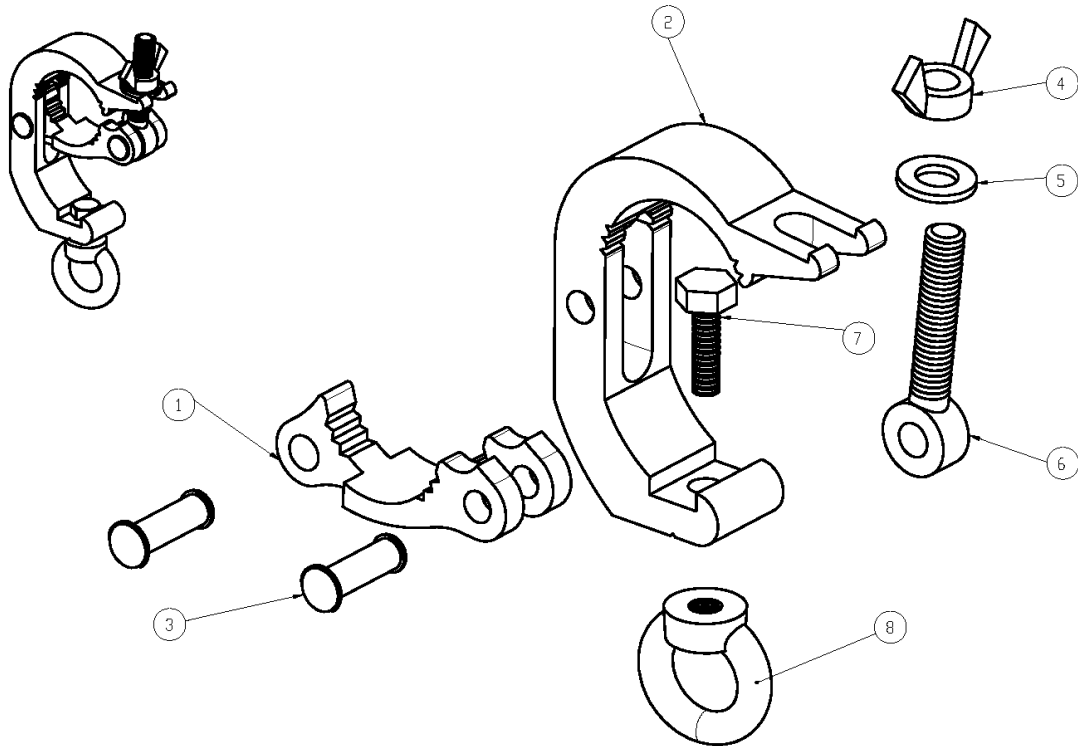

Numero	Codice	Descrizione	Quantità
1	GC/01A convesso* GC/01AN convesso**	Parte convessa in alluminio Sp. 31mm Parte convessa in alluminio verniciata nera Sp. 31mm	1
2	GC/01A concavo* GC/01AN concavo**	Parte concava in alluminio Sp. 31mm Parte concava in alluminio verniciata nera Sp. 31mm	1
3	R1035	Ribattino semiforato dim.10x35, zincato testa piatta	2
4	DAL12	Dado M12 ad aletta, zincato	1
5	RD12	Rondella Ø24mm est., foro int. Ø12 mm , zincata	1
6	OC/F11	Occhiello filettato M12, Øest. 23.5mm, Øint 11.5 mm	1
7	B1025/EZ	Bullone M10x25mm testa esagonale zincato, filetto intero	1
8	G10	Golfare femmina M10	1
GC/01AG* - GANCIO A "C" IN ALLUMINIO Sp. 31mm CON GOLFARE GC/01ANG** - GANCIO A "C" IN ALLUMINIO VERNICIATO NERO Sp. 31mm CON GOLFARE			



PRESCRIZIONI DI UTILIZZO E ISTRUZIONI DI MONTAGGIO

Prescrizioni per l'utilizzo:

1. Non superare il carico di lavoro indicato nella scheda tecnica;
2. Utilizzare il gancio esclusivamente entro i parametri del tubo di progetto;
3. Ispezionare visivamente il gancio prima dell'uso. In caso di danneggiamento mettere fuori servizio;
4. Combinati con altri accessori, prestare attenzione a non superare la portata minima di qualsiasi componente;
5. Il gancio va utilizzato solo nella configurazione verticale illustrata in fig.1. In caso contrario ridurre il carico;



Figura 1 Configurazione di lavoro.

6. Per un corretto utilizzo applicare al dispositivo di serraggio su tubo un momento torcente pari a 32 Nm.

Istruzioni di montaggio:

[Per le istruzioni di montaggio e per ulteriori chiarimenti si rimanda al sito \[www.efestoproduction.com\]\(http://www.efestoproduction.com\) alla sezione **Ganci**.](http://www.efestoproduction.com)

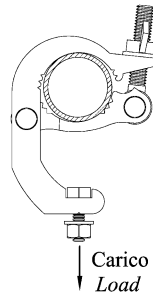

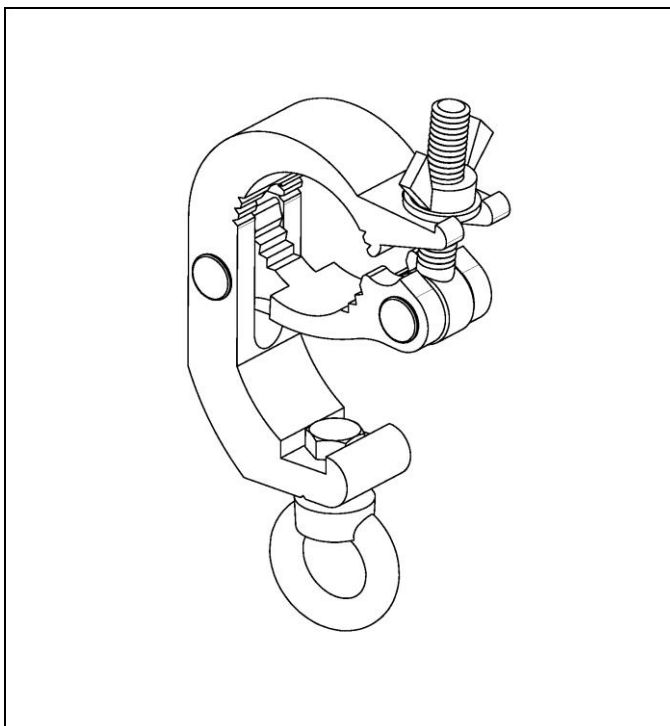
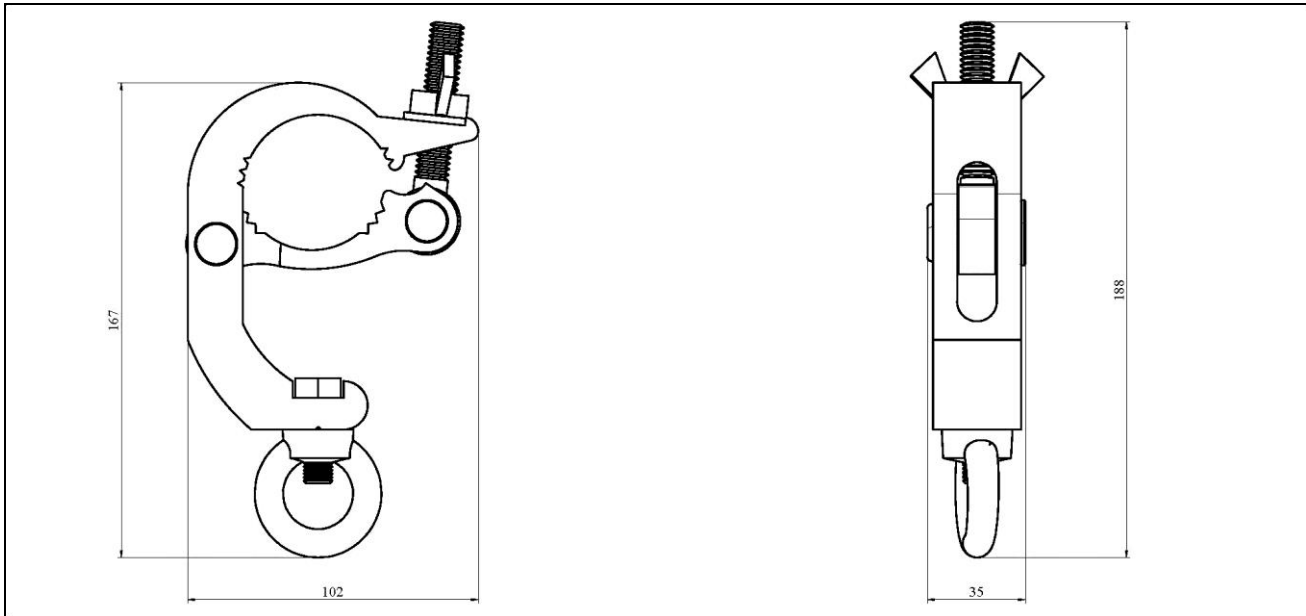

Scheda Tecnica / Datasheet

Dimensioni / Dimensions

102x188x35 mm

Materiale / Material

Lega EN AW 6060-T6

Finitura superficiale / Surface finish

*Alluminio lucido / Polished aluminium

**Verniciato nero / Painted black

Peso / Weight

0.600 kg

Volume trasporto / Transport volume

 0.00067 m³
Portata / Max. load

100kg

Note / Notes

 Min. sezione tubo (*Min. pipe section*) – 48 mm

 Max. sezione tubo (*Max. pipe section*) – 51 mm

SERIE GANCI

Si riportano, di seguito, la serie di ganci prodotti, disponibili in alluminio lucido o verniciato nero:

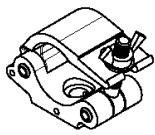

AS01



AS01S

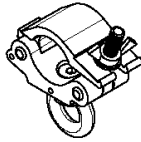

AG04



AG04S

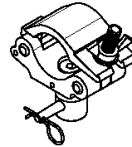

AM02

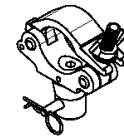

AM02S

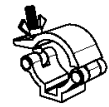

AS01/60



AS01/60G



AS01/60M02

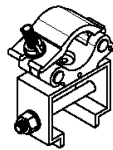

AS01/GCS

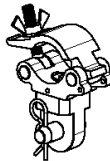

AS01/ST5050

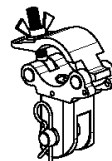

AS01/SU5050

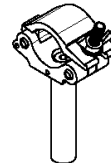

AS28

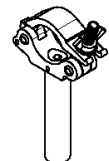

AS28S

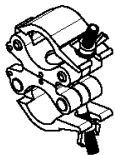

AD03



AD03S



AD03/60

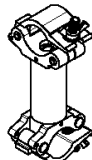

B/AS01



GC/01



GC/01A



GC/01AG



GC/01AM02



GC/01S



GC/01V

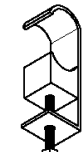

GC/02



GC/02A



GC/03A



GC/03AG



GC/03AM02



GC/04A



GC/04AG

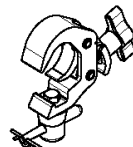

GC/04AM02



GC/05A



GC/05AG



GC/05AM02

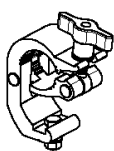

GC/06A



GC/06AG

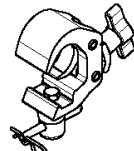

GC/06AM02

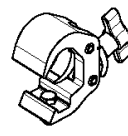

GC/07A

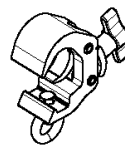

GC/07AG

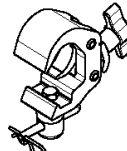

GC/07AM02

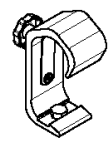

GC/08A

