

GC/05AM02*
GC/05ANM02**

GANCIO A "C" IN ALLUMINIO Sp.50mm CON M02
COMPATIBILE TUBO DIAMETRO DA 48 A 51 mm
PORTATA 250 KG

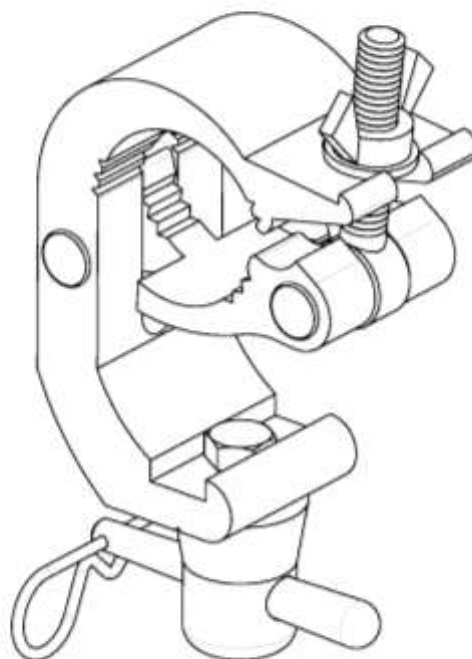

Finitura alluminio lucido() o verniciato nero(**)*



ASSEMBLAGGIO ACCESSORI

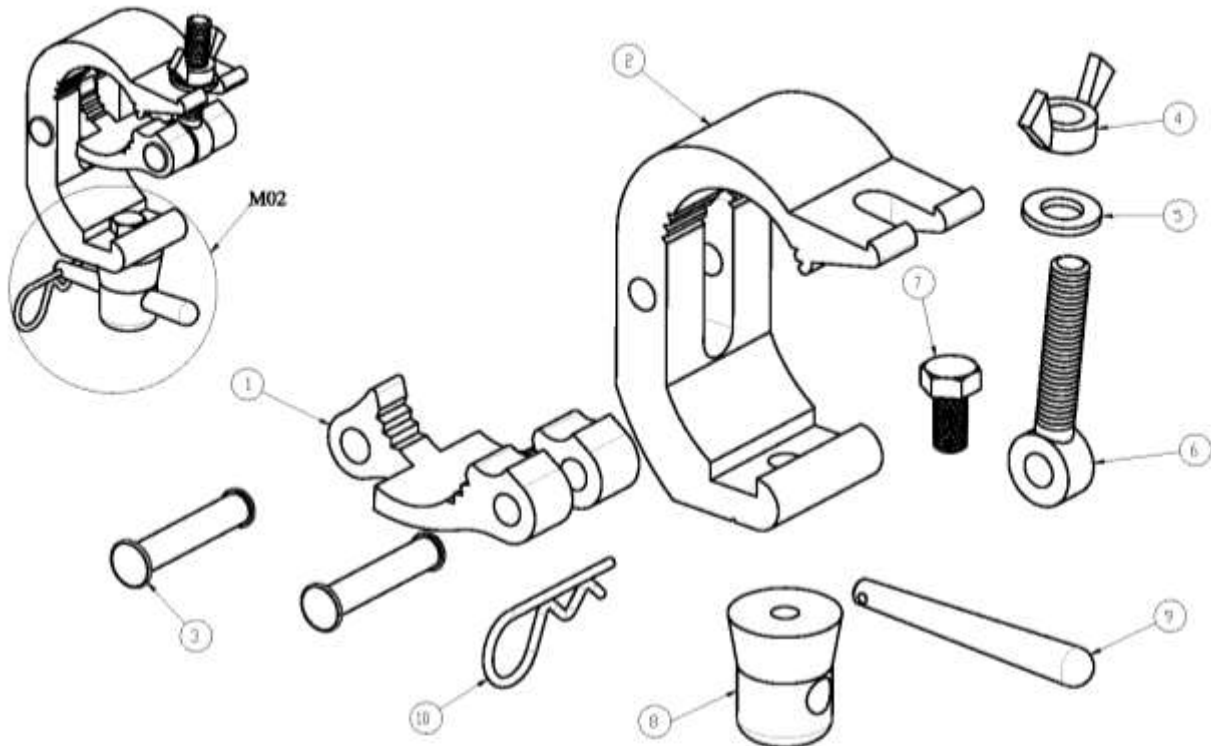

Numero	Codice	Descrizione	QUANTITA'
1	GC/05A convesso	Parte convessa in "Al" SP.50mm	1
2	GC/05A concavo	Parte concava in "Al" Sp. 50mm	1
3	R1054	Rivetto semiforato testa piatta Ø10x54mm, zincato	2
4	DAL12	Dado ad alette zincato M12	1
5	RD12	Rondella Ø 12 mm	1
6	OC/F11	Occhiello filettato M12	1
7	B1020_EZ	Bullone esagonale M10x20mm tutto filetto, zincato	1
8	99/F10	1/2 spinotto in acciaio Ø 34.7, foro M10	1
9	S	Spina conica in acciaio Lungh.90 mm	1
10	F603-DG	Fermo di sicurezza in acciaio zincato dim.60x3 mm	1

GC/05AM02 - GANCIO A "C" IN ALLUMINIO Sp. 50mm CON "M02"

GC/05ANM02 - GANCIO A "C" IN ALLUMINIO Sp. 50mm CON "M02" VERNICIATO NERO



PRESCRIZIONI DI UTILIZZO E ISTRUZIONI DI MONTAGGIO

Prescrizioni per l'utilizzo:

1. Non superare il carico di lavoro indicato nella scheda tecnica;
2. Utilizzare il gancio esclusivamente entro i parametri del tubo di progetto;
3. Ispezionare visivamente il gancio prima dell'uso. In caso di danneggiamento mettere fuori servizio;
4. Combinati con altri accessori, prestare attenzione a non superare la portata minima di qualsiasi componente;
5. Il gancio va utilizzato solo in un orientamento verticale (Fig.1). In caso contrario ridurre li carico;



Figura 1 Configurazione di lavoro.

6. Per un corretto utilizzo applicare al dispositivo di serraggio su tubo un momento torcente pari a 32 Nm.

Istruzioni di montaggio:

[Per le istruzioni di montaggio e per ulteriori chiarimenti si rimanda al sito \[www.efestoproduction.com\]\(http://www.efestoproduction.com\) alla sezione **Ganci**.](http://www.efestoproduction.com)

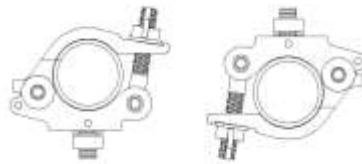

SCHEDA TECNICA GC/05AM02* - GC/05ANM02**

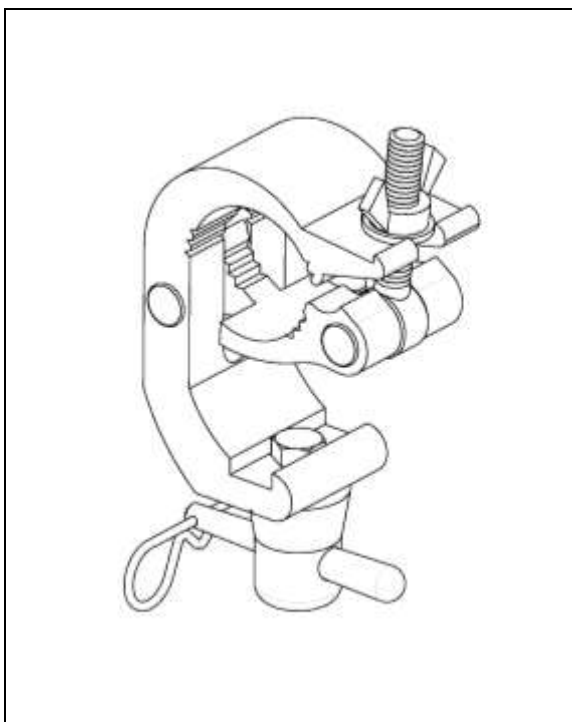
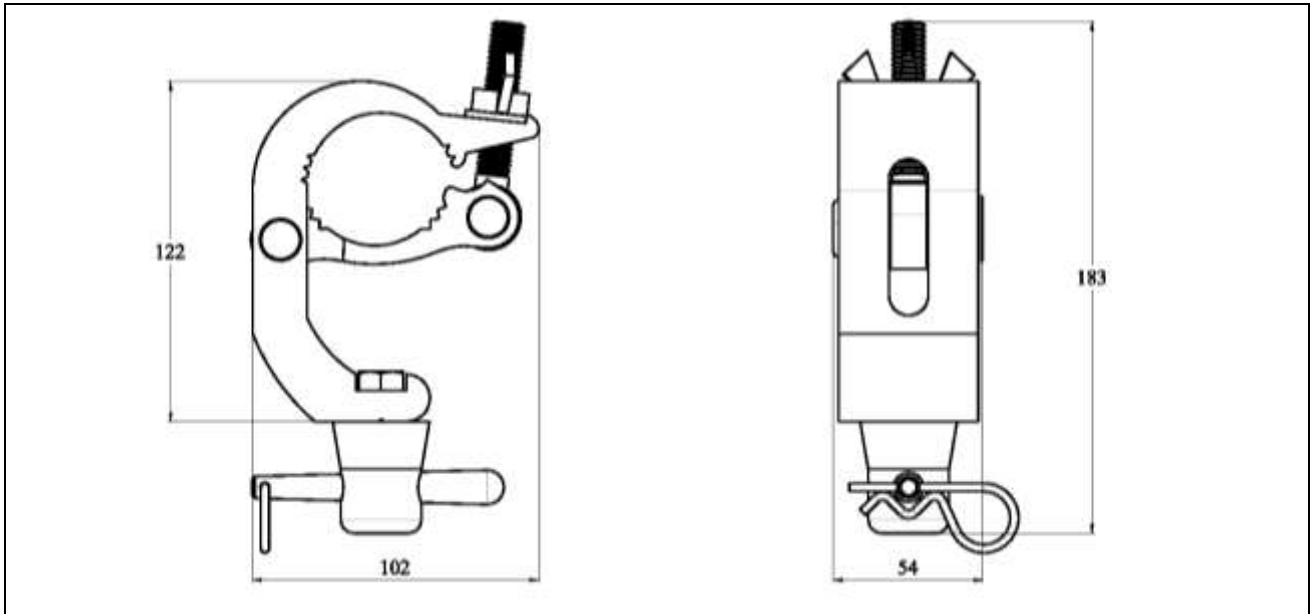
 Scheda Tecnica / *Datasheet*
Dimensioni / Dimensions

102x188x54 mm

Materiale / Material

Lega EN AW 6060-T6

Finitura superficiale / Surface finish

 *Alluminio lucido / *Polished aluminium*

 **Verniciato nero / *Painted black*
Peso / Weight

0.890 kg

Volume trasporto / Transport volume

 0.0010 m³
Portata / Max. load

250kg

Note / Notes

 Min. sezione tubo (*Min. pipe section*) – 48 mm

 Max. sezione tubo (*Max. pipe section*) – 51 mm

www.efestoproduction.com - info@efestoproduction.com

 Efesto Production Srl Via Orta Loreto loc. Taurana 84012 Angri SA Italy ISO 9001:2008 Certified Company
 Tel. + 39 081 5187923 / + 39 081 5156116 - Fax + 39 081 5165028

SERIE GANCI

Si riportano, di seguito, la serie di ganci prodotti, disponibili in alluminio lucido o verniciato nero:

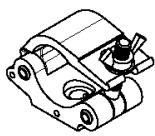

AS01



AS01S

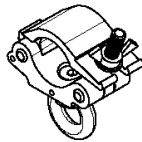

AG04



AG04S

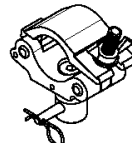

AM02

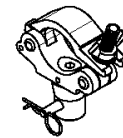

AM02S



AS01/60



AS01/60G



AS01/60M02

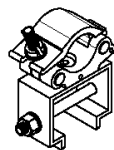

AS01/GCS

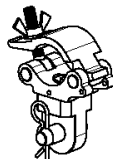

AS01/ST5050

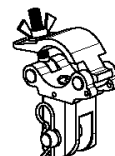

AS01/SU5050

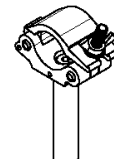

AS28

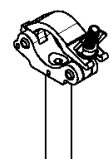

AS28S

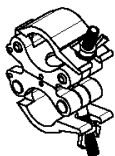

AD03



AD03S

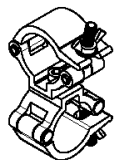

AD03/60

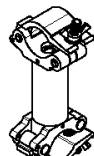

B/AS01



GC/01



GC/01A



GC/01AG



GC/01AM02



GC/01S

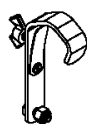

GC/01V

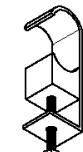

GC/02

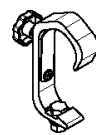

GC/02A



GC/03A



GC/03AG



GC/03AM02



GC/04A



GC/04AG



GC/04AM02

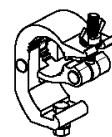

GC/05A



GC/05AG



GC/05AM02

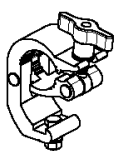

GC/06A

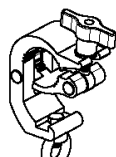

GC/06AG

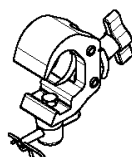

GC/06AM02

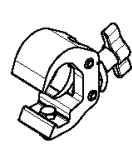

GC/07A

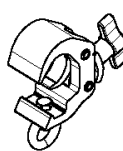

GC/07AG

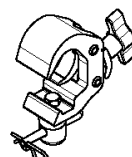

GC/07AM02

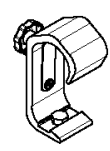

GC/08A

